

# Joint Evaluation Report

**ESR-1144**

Reissued August 2018

Revised June 2020

This report is subject to renewal August 2020.

[www.icc-es.org](http://www.icc-es.org) | (800) 423-6587 | (562) 699-0543

A Subsidiary of the International Code Council®

**DIVISION: 06 00 00—WOOD, PLASTICS AND COMPOSITES**

**Section: 06 17 33—Wood I-Joists**

**REPORT HOLDER:**

**BOISE CASCADE WOOD PRODUCTS, LLC**

**EVALUATION SUBJECT:**

**AJS SERIES PREFABRICATED WOOD I-JOISTS**

**1.0 EVALUATION SCOPE**

**Compliance with the following codes:**

- 2018, 2015, 2012, 2009 and 2006 *International Building Code*® (IBC)
- 2018, 2015, 2012, 2009 and 2006 *International Residential Code*® (IRC)

**Property evaluated:**

Structural

**2.0 USES**

AJS I-joists are prefabricated wood I-joists used as floor joists, roof rafters, blocking panels and rim boards, to support code-required loads. Prefabricated wood I-joists described in this report comply with Section 2303.1.2 of the IBC and Section R502.1.2 of the 2018 and 2015 IRC or Section R502.1.4 of the 2012 IRC, for allowable stress design.

**3.0 DESCRIPTION**

**3.1 General:**

The AJS Series prefabricated wood I-joists have solid-sawn lumber or laminated veneer lumber flanges, and oriented strand board (OSB) webs. The top and bottom flanges are parallel, creating constant-depth joists. The web-to-web joints of the I-joists are square butt joints and conform to the specifications in the approved quality documentation. The web-to-flange connection is a proprietary grooved connection, also conforming to the approved quality documentation. Additionally, AJS I-joists are also manufactured with proprietary FireBreak HITS™, Thermax™ and HHO™ fire protective materials factory-applied to both faces of the web, as specified in the approved quality documentation. The AJS I-joists are available in various lengths and depths. See Table 1 for a description of the I-joists.

**3.2 Material Specifications:**

**3.2.1 Flanges:** The flanges of the I-joists are sawn lumber or laminated veneer lumber (LVL) conforming to the

specifications in the approved quality documentation. The LVL lumber flanges are 1½-inch-by-2½-inch (38 by 64 mm) spruce-pine-fir (SPF) proprietary grade LVL and are used interchangeably with any of the sawn lumber flanges of the same dimensions. The sawn lumber flange material, grade, width and depth are noted in Table 1.

**3.2.2 Web:** Web material for the I-joists is ¾-inch-thick (10 mm) or 7/16-inch-thick (11 mm) OSB conforming to Exposure 1 requirements of DOC PS-2, with further requirements set forth in the approved quality documentation and manufacturing standards.

**3.2.3 Adhesive:** Adhesives used in the fabrication of the I-joists are exterior-type, heat-durable adhesives complying with ASTM D2559 and ASTM D5055, and are specified in the quality documentation and the manufacturing standards.

**4.0 DESIGN AND INSTALLATION**

Design of the prefabricated wood I-joists described in this report must be in accordance with the applicable code. Additionally, the design and installation of the prefabricated wood I-joists must comply with Sections 4.1 through 4.13, and the manufacturer’s installation instructions.

**4.1 Reference Design Values:**

The reference design moments, vertical shear capacity, I-joist stiffness (*EI*), and reactions are specified in Table 2. Reference design end reactions are based on a minimum bearing length of 1½ inches (38 mm) for simple spans on joists having depths of 9¼ to 16 inches (235 mm to 406 mm), and 1¾ inches (44.5 mm) on joists having depths of 18 inches (457 mm) or greater. Reference design intermediate reactions are based on a minimum bearing length of 3½ inches (89 mm) at intermediate support points for continuous spans. Floor assemblies, consisting of a minimum 23/32-inch-thick (18 mm) Sturd-I-Floor rated sheathing nailed to the I-joists in accordance with the applicable code requirements and adhered to the top flanges of the I-joists using AFG-01 construction adhesive or construction adhesive complying with ASTM D3498, have the allowable spans shown in Table 3.

**4.2 Fasteners:**

Reference withdrawal design values and lateral load values, for nails installed into the flanges, must be determined in accordance with the applicable code, using a specific gravity as shown in Table 1. Fastener spacing must comply with the minimum spacing requirements prescribed by the applicable code for nails installed in sawn lumber.

**4.3 Web Stiffeners:**

Web stiffener requirements for the I-joists at reaction and concentrated load locations are noted in Figure 1.

**4.4 Lateral Support:**

Lateral restraint must be provided at supports (e.g., through attachment to blocking panels, rim board) to prevent rotation and along the compression flange of each joist (e.g., through attachment to wood structural panel sheathing, gypsum board ceiling, wood structural panel soffit).

**4.5 Holes in I-joist Web:**

Holes in the web of the I-joist are permitted as follows: for I-joists with a simple span and supporting uniform loads only, holes in the webs must be in accordance with Tables 5 and 6 (for round holes) or Tables 7 and 8 (for square and rectangular holes). The reduced shear capacity due to the presence of holes in the web,  $V_{hole}$ , must be calculated as follows:

For round holes:

$$V_{hole} = V_r \left[ B_c - M_c \left( \frac{\text{hole diameter}}{\text{joist depth} - 2 \times \text{flanged depth}} \right) \right]$$

For square and rectangular holes:

$$V_{hole} = V_r \left[ B_R - 0.28 \left( \frac{\text{hole depth}}{\text{joist depth} - 2 \times \text{flanged depth}} \right) - 0.29 \left( \frac{\text{hole width}}{18} \right) \right]$$

where:

$V_r$  is the shear value, for the joist, provided in Table 2.

$B_c$  = 0.88 for joist depths less than or equal to 16 inches;  
 0.91 for joist depths greater than 16 inches.

$M_c$  = 0.69 for joist depths less than or equal to 16 inches;  
 0.84 for joist depths greater than 16 inches

$B_R$  = 0.60 for joist depths less than or equal to 16 inches;  
 0.57 for joist depths greater than 16 inches.

Where multiple holes occur in the web, the minimum edge-to-edge spacing between holes must be two times the size of the largest dimension of either hole.

**4.6 Duration of Load:**

Adjustments for duration of load must be in accordance with Sections 7.3.2 and 10.3.2 of the ANSI/AWC *National Design Specification® for Wood Construction* (NDS).

**4.7 In-service Moisture Conditions:**

I-joists must be installed in dry, covered conditions where the in-service moisture content of the wood does not exceed 16 percent.

**4.8 Repetitive-member Use:**

The repetitive-member use factor applicable to the resistive moment capacities listed in Table 2 is limited to 1.0.

**4.9 Member Spans:**

I-joist spans must be determined in accordance with Section 3.2.1 of the NDS and the applicable code. Shear calculations must include all loads within the span from face to face of supports.

**4.10 Deflection:**

Total I-joist deflection must be calculated using the formula for deflection due to bending and the following formula for deflection due to shear:

$$\Delta_{shear} = \frac{8M}{K}$$

where:

$\Delta_{shear}$  = Deflection caused by shear stress [inches (mm)].

$M$  = Design moment [inch-lbs (mm-N)].

$K$  = Shear modulus constant in Table 2 [in-lbs/in (mm-N/mm)].

Deflection of a uniformly loaded, simple-span I-joist must be determined using the following formula:

$$\Delta_{Total} = \Delta_{bending} + \Delta_{shear} = \frac{5wL^4}{384EI} + \frac{wL^2}{K}$$

Deflection of a simple-span I-joist with a concentrated load at mid-span must be determined using the following formula:

$$\Delta_{Total} = \Delta_{bending} + \Delta_{shear} = \frac{PL^3}{48EI} + \frac{2PL}{K}$$

where:

$\Delta_{Total}$  = Total I-joist deflection [inches (mm)].

$w$  = Applied uniform loads [lbf/inch (N/mm)].

$P$  = Applied concentrated load [lbf (N)].

$L$  = I-joist span [inches (mm)].

$EI$  = I-joist stiffness from Table 2 [in<sup>2</sup>-lbf].

$M$  = Design moment [inch-lbs (mm-N)].

$K$  = Shear modulus constant from Table 2 [in-lbf/in].

**4.11 Blocking Panels and Rim Boards:**

Bearing walls perpendicular to and supported by I-joists require full depth blocking, or rim joists, at supports. I-joists used as blocking panels must be installed between I-joists and have the maximum applicable vertical load capacities shown in Table 2. When used as rim boards or as diaphragm framing members, AJS I-joists must be designed in accordance with the vertical and lateral load capacities shown in Tables 2 and 4.

**4.12 Cantilevered Joists:**

I-joists may be installed with cantilevers, provided the cantilevered portion does not exceed a maximum length equal to one-third of the adjacent span. Additionally, the cantilevered I-joist must be limited to supporting only uniform loads, unless additional design details are provided by a design professional.

**4.13 Fire Protection of Floors:**

AJS series I-joists installed and protected as specified in Figures 3 through 10 are alternatives to the 2-by-10 dimension lumber prescribed in 2018 and 2015 IRC Section R302.13 or 2012 IRC Section R501.3, Exceptions 1 and 2, and Exception 4, and have met the requirements for a floor assembly demonstrating equivalent fire performance. AJS series I-joists installed and protected as specified in Figure 11 meet the provisions of 2018 and 2015 IRC Section R302.13 or 2012 IRC Section R501.3.

**5.0 CONDITIONS OF USE**

The AJS Series I-joists described in this report comply with, or are suitable alternatives to what is specified in, those codes listed in Section 1.0 of this report, subject to the following conditions:

- 5.1 AJS I-joists must be installed in accordance with this report and the manufacturer’s installation instructions.
- 5.2 Calculations and design details verifying compliance with this report must be submitted to the code official when requested. The calculations and details must be prepared by a registered design professional where required by the statutes of the jurisdiction in which the project is to be constructed.
- 5.3 Cutting or notching of AJS I-joist flanges is beyond the scope of this report.
- 5.4 AJS I-joists and AJS I-joists with FireBreak HITS™, Thermax™, and HHO™ fire protective materials are manufactured by Boise Cascade Wood Products, LLC at their plant located in St. Jacques, New Brunswick, Canada, under an approved quality-control program with inspections by ICC-ES and APA—The Engineered Wood Association (AA-649).

**6.0 EVIDENCE SUBMITTED**

Data in accordance with the ICC-ES Acceptance Criteria for Prefabricated Wood I-joists (AC14), dated June 2019; and the ICC-ES Acceptance Criteria for Rim Board Products (AC124), dated June 2019.

**7.0 IDENTIFICATION**

AJS I-joists are identified by a stamp indicating the joist model; company name (Boise Cascade Wood Products, LLC); manufacturing location; evaluation report number (ESR-1144); and the name and logo of the inspection agency (APA—The Engineered Wood Association).

7.1 The report holder’s contact information is the following:

**BOISE CASCADE WOOD PRODUCTS, LLC**  
**POST OFFICE BOX 2400**  
**WHITE CITY, OREGON 97503-0400**  
**(800) 232-0788**  
[www.bcewp.com](http://www.bcewp.com)

**TABLE 1—DESCRIPTION FOR AJS I-JOISTS**

JOIST SERIES	FLANGE			WEB MATERIAL	RANGE OF JOIST DEPTHS (inches)
	Material <sup>1</sup>	Dimensions (depth x width) (inches)	Specific Gravity		
AJS-5	APG SPF	1.5 x 2.5	0.42	3/8-inch OSB	9 1/2 to 11 7/8
AJS-10	APG Black Spruce	1.5 x 2.5	0.42	3/8-inch OSB	9 1/2 to 16
AJS-20	MSR 2100F <sub>b</sub> – 1.8E	1.5 x 2.5	0.46	3/8-inch OSB	9 1/2 to 16
AJS-20v	MSR 2100F <sub>b</sub> – 1.8E	1.5 x 2.5	0.46	3/8-inch OSB	9 1/4 to 16
AJS-110	APG SPF	1.5 x 2.5	0.42	3/8-inch OSB	9 1/4 to 16
AJS-140	APG SPF	1.5 x 2.5	0.42	3/8-inch OSB	9 1/2 to 16
AJS-150	MSR 1650F <sub>b</sub> – 1.5E	1.5 x 2.5	0.42	3/8-inch OSB	9 1/2 to 16
AJS-150v	MSR 1650F <sub>b</sub> – 1.5E	1.5 x 2.5	0.42	3/8-inch OSB	9 1/4 to 16
AJS-160	MSR 1800F <sub>b</sub> – 1.6E	1.5 x 2.5	0.42	3/8-inch OSB	9 1/2 to 16
AJS-170	MSR 1950F <sub>b</sub> – 1.7E	1.5 x 2.5	0.42	3/8-inch OSB	9 1/2 to 16
AJS-180	MSR 2100F <sub>b</sub> – 1.8E	1.5 x 2.5	0.46	3/8-inch OSB	9 1/2 to 16
AJS-190	MSR 2250F <sub>b</sub> – 1.9E	1.5 x 2.5	0.46	3/8-inch OSB	9 1/4 to 16
				7/16-inch OSB	18 to 20
AJS-200	MSR 2400F <sub>b</sub> – 2.0E	1.5 x 2.5	0.50	3/8-inch OSB	9 1/2 to 16
AJS-24	MSR 1650F <sub>b</sub> – 1.5E	1.5 x 3.5	0.42	3/8-inch OSB	9 1/4 to 16
AJS-25	MSR 2100F <sub>b</sub> – 1.8E	1.5 x 3.5	0.46	3/8-inch OSB	9 1/2 to 16
				7/16-inch OSB	18 to 24
AJS-25v	MSR 2100F <sub>b</sub> – 1.8E	1.5 x 3.5	0.46	3/8-inch OSB	9 1/4 to 16
AJS-30	MSR 2400F <sub>b</sub> – 2.0E	1.5 x 3.5	0.50	7/16-inch OSB	18 to 24

For **SI**: 1 inch = 25.4 mm.

<sup>1</sup>APG =AJS Proprietary Grade; SPF = Spruce-pine-fir; MSR = Machine Stress Rated lumber (SPF)

TABLE 2—REFERENCE DESIGN PROPERTIES FOR AJS I-JOISTS<sup>1</sup>

JOIST SERIES	DEPTH (in.)	MOMENT $M_r$ (ft-lb)	SHEAR $V_r$ (lb)	$EI^2 \times 10^6$ (lb-in <sup>2</sup> )	$K^2 \times 10^6$ (in-lb/in)	END REACTION, $R_r$ (lb) <sup>9</sup>				INTERMEDIATE REACTION, $R_r$ (lb) <sup>9</sup>				BLOCKING PANEL <sup>6,11</sup> (lb/ft)	WEIGHT (lb/ft) <sup>10</sup>
						With 1 $\frac{1}{2}$ " Bearing <sup>3,7</sup>		With 3 $\frac{1}{2}$ " Bearing		With 3 $\frac{1}{2}$ " Bearing <sup>3</sup>		With 5 $\frac{1}{4}$ " Bearing			
						No <sup>4</sup>	Yes <sup>5</sup>	No <sup>4</sup>	Yes <sup>5</sup>	No <sup>4</sup>	Yes <sup>5</sup>	No <sup>4</sup>	Yes <sup>5</sup>		
AJS-5	9 $\frac{1}{2}$	2,175	1,160	182	5.2	950	1,200	1,175	1,480	2,350	2,450	2,350	2,450	1,875	2.2
	11 $\frac{7}{8}$	2,820	1,490	310	6.6	955	1,335	1,215	1,595	2,390	2,800	2,390	2,800	1,680	2.5
AJS-10	9 $\frac{1}{2}$	2,960	1,160	232	5.2	950	1,240	1,175	1,480	2,350	2,450	2,350	2,450	1,875	2.5
	11 $\frac{7}{8}$	3,835	1,490	394	6.6	955	1,335	1,215	1,595	2,390	2,800	2,390	2,800	1,680	2.8
	14	4,620	1,790	578	7.8	960	1,420	1,250	1,700	2,430	3,130	2,430	3,130	1,500	3.0
	16	5,355	2,065	786	9.0	970	1,500	1,285	1,800	2,465	3,435	2,465	3,435	1,340	3.3
AJS-20	9 $\frac{1}{2}$	3,395	1,160	232	5.2	950	1,240	1,175	1,480	2,350	2,450	2,350	2,450	1,875	2.5
	11 $\frac{7}{8}$	4,400	1,490	394	6.6	955	1,335	1,215	1,595	2,390	2,800	2,390	2,800	1,680	2.8
	14	5,295	1,790	578	7.8	960	1,420	1,250	1,700	2,430	3,130	2,430	3,130	1,500	3.0
	16	6,140	2,065	786	9.0	970	1,500	1,285	1,800	2,465	3,435	2,465	3,435	1,340	3.3
AJS-20v	9 $\frac{1}{4}$	3,675	1,130	218	5.1	1,075	1,075	1,120	1,120	2,350	2,450	2,850	2,950	2,000	2.5
	9 $\frac{1}{2}$	3,795	1,160	232	5.2	1,075	1,075	1,145	1,145	2,350	2,450	2,850	2,950	2,000	2.5
	11 $\frac{1}{4}$	4,620	1,400	347	6.2	1,175	1,175	1,355	1,355	2,500	2,800	3,000	3,250	2,000	2.8
	11 $\frac{7}{8}$	4,915	1,490	394	6.6	1,175	1,175	1,425	1,425	2,500	2,800	3,000	3,250	2,000	2.8
	14	5,920	1,790	579	7.8	1,175	1,175	1,475	1,665	2,500	3,150	3,000	3,500	2,000	3.0
	16	6,865	2,065	789	8.9	1,175	1,175	1,475	1,885	2,500	3,500	3,000	3,500	2,000	3.3
AJS-110	9 $\frac{1}{4}$	1,805	1,125	135	5.0	950	1,230	1,170	1,480	2,350	2,450	2,350	2,450	1,875	2.5
	9 $\frac{1}{2}$	1,865	1,160	144	5.2	950	1,240	1,175	1,480	2,350	2,450	2,350	2,450	1,875	2.5
	11 $\frac{1}{4}$	2,270	1,400	218	6.2	955	1,310	1,205	1,595	2,390	2,800	2,390	2,800	1,680	2.8
	11 $\frac{7}{8}$	2,415	1,490	248	6.6	955	1,335	1,215	1,595	2,390	2,800	2,390	2,800	1,680	2.8
	14	2,910	1,790	367	7.8	960	1,420	1,250	1,700	2,415	3,130	2,415	3,130	1,500	3.0
	16	3,315	2,065	504	9.0	970	1,500	1,285	1,800	2,440	3,435	2,440	3,435	1,340	3.3
AJS-140	9 $\frac{1}{2}$	2,450	1,160	182	5.2	950	1,240	1,175	1,480	2,350	2,450	2,350	2,450	1,875	2.2
	11 $\frac{7}{8}$	3,175	1,490	310	6.6	955	1,335	1,215	1,595	2,390	2,800	2,390	2,800	1,680	2.5
	14	3,825	1,790	457	7.8	960	1,420	1,250	1,700	2,430	3,130	2,430	3,130	1,500	2.8
	16	4,435	2,065	623	9.0	970	1,500	1,285	1,800	2,465	3,435	2,465	3,435	1,340	3.1
AJS-150	9 $\frac{1}{2}$	2,820	1,160	194	5.2	950	1,240	1,175	1,480	2,350	2,450	2,350	2,450	1,875	2.2
	11 $\frac{7}{8}$	3,650	1,490	331	6.6	955	1,335	1,215	1,595	2,390	2,800	2,390	2,800	1,680	2.5
	14	4,390	1,790	487	7.8	960	1,420	1,250	1,700	2,430	3,130	2,430	3,130	1,500	2.7
	16	5,090	2,065	664	9.0	970	1,500	1,285	1,800	2,465	3,435	2,465	3,435	1,340	3.0
AJS-150v	9 $\frac{1}{4}$	2,740	1,130	182	5.1	1,075	1,075	1,120	1,120	2,350	2,450	2,850	2,950	2,000	2.2
	9 $\frac{1}{2}$	2,820	1,160	194	5.2	1,075	1,075	1,145	1,145	2,350	2,450	2,850	2,950	2,000	2.2
	11 $\frac{1}{4}$	3,430	1,400	292	6.2	1,175	1,175	1,355	1,355	2,500	2,800	3,000	3,250	2,000	2.5
	11 $\frac{7}{8}$	3,650	1,490	331	6.6	1,175	1,175	1,425	1,425	2,500	2,800	3,000	3,250	2,000	2.5
	14	4,390	1,790	487	7.8	1,175	1,175	1,475	1,665	2,500	3,150	3,000	3,500	2,000	2.7
	16	5,090	2,065	664	9.0	1,175	1,175	1,475	1,885	2,500	3,500	3,000	3,500	2,000	3.0
AJS-160	9 $\frac{1}{2}$	3,057	1,160	207	5.2	950	1,240	1,175	1,480	2,350	2,450	2,350	2,450	1,875	2.4
	11 $\frac{7}{8}$	3,959	1,490	352	6.6	955	1,335	1,215	1,595	2,390	2,800	2,390	2,800	1,680	2.7
	14	4,767	1,790	517	7.8	960	1,420	1,250	1,700	2,430	3,130	2,430	3,130	1,500	2.9
	16	5,527	2,065	705	9.0	970	1,500	1,285	1,800	2,465	3,435	2,465	3,435	1,340	3.2
AJS-170	9 $\frac{1}{2}$	3,300	1,160	219	5.2	950	1,240	1,175	1,480	2,350	2,450	2,350	2,450	1,875	2.5
	11 $\frac{7}{8}$	4,270	1,490	372	6.6	955	1,335	1,215	1,595	2,390	2,800	2,390	2,800	1,680	2.8
	14	5,140	1,790	547	7.8	960	1,420	1,250	1,700	2,430	3,130	2,430	3,130	1,500	3.0
	16	5,960	2,065	746	9.0	970	1,500	1,285	1,800	2,465	3,435	2,465	3,435	1,340	3.3
AJS-180	9 $\frac{1}{2}$	3,640	1,160	232	5.2	950	1,240	1,175	1,480	2,350	2,450	2,350	2,450	1,875	2.5
	11 $\frac{7}{8}$	4,710	1,490	394	6.6	955	1,335	1,215	1,595	2,390	2,800	2,390	2,800	1,680	2.8
	14	5,675	1,790	578	7.8	960	1,420	1,250	1,700	2,430	3,130	2,430	3,130	1,500	3.0
	16	6,580	2,065	786	9.0	970	1,500	1,285	1,800	2,465	3,435	2,465	3,435	1,340	3.3
AJS-190	9 $\frac{1}{4}$	3,770	1,125	229	5.1	950	1,230	1,170	1,480	2,350	2,450	2,350	2,450	1,875	2.5
	9 $\frac{1}{2}$	3,895	1,160	244	5.2	950	1,240	1,175	1,480	2,350	2,450	2,350	2,450	1,875	2.5
	11 $\frac{1}{4}$	4,740	1,400	365	6.2	955	1,310	1,205	1,595	2,390	2,800	2,390	2,800	1,680	2.8
	11 $\frac{7}{8}$	5,045	1,490	414	6.6	955	1,335	1,215	1,595	2,390	2,800	2,390	2,800	1,680	2.8
	14	6,070	1,790	608	7.8	960	1,420	1,250	1,700	2,430	3,130	2,430	3,130	1,500	3.0
	16	7,040	2,065	827	9.0	970	1,500	1,285	1,800	2,465	3,435	2,465	3,435	1,340	3.3
	18	8,045	3,010	1,100	12.1	N/A	2,160	N/A	2,620	N/A	4,720	N/A	4,720	2,700 <sup>8</sup>	4.6
	20	8,990	3,240	1,402	13.5	N/A	2,160	N/A	2,980	N/A	4,780	N/A	5,110	2,700 <sup>8</sup>	4.9
AJS-200	9 $\frac{1}{2}$	4,155	1,160	257	5.2	950	1,240	1,175	1,480	2,350	2,450	2,350	2,450	1,875	2.6
	11 $\frac{7}{8}$	5,385	1,490	435	6.6	955	1,335	1,215	1,595	2,390	2,800	2,390	2,800	1,680	2.9
	14	6,485	1,790	638	7.8	960	1,420	1,250	1,700	2,430	3,130	2,430	3,130	1,500	3.1
	16	7,515	2,065	868	9.0	970	1,500	1,285	1,800	2,465	3,435	2,465	3,435	1,340	3.4
AJS-24	9 $\frac{1}{4}$	3,880	1,125	253	5.2	950	1,230	1,170	1,480	2,600	2,850	2,600	2,850	1,875	3.0
	9 $\frac{1}{2}$	4,005	1,160	270	5.3	950	1,240	1,175	1,480	2,600	2,850	2,600	2,850	1,875	3.1
	11 $\frac{1}{4}$	4,875	1,400	403	6.3	955	1,310	1,205	1,595	2,690	3,190	2,690	3,190	1,680	3.3
	11 $\frac{7}{8}$	5,190	1,490	457	6.7	955	1,335	1,215	1,595	2,690	3,190	2,690	3,190	1,680	3.4
	14	6,250	1,790	670	7.9	960	1,420	1,250	1,700	2,770	3,500	2,770	3,500	1,500	3.7
	16	7,245	2,065	911	9.1	970	1,500	1,285	1,800	2,850	3,800	2,850	3,800	1,340	3.9

TABLE 2—REFERENCE DESIGN PROPERTIES FOR AJS I-JOISTS<sup>1</sup> (Continued)

JOIST SERIES	DEPTH (in.)	MOMENT M <sub>r</sub> (ft-lb)	SHEAR V <sub>r</sub> (lb)	EI <sup>2</sup> X 10 <sup>6</sup> (lb-in <sup>2</sup> )	K <sup>2</sup> x 10 <sup>6</sup> (in-lb/in)	END REACTION, R <sub>r</sub> (lb) <sup>9</sup>				INTERMEDIATE REACTION, R <sub>r</sub> (lb) <sup>9</sup>				BLOCKING PANEL <sup>6,11</sup> (lb/ft)	WEIGHT (lb/ft) <sup>10</sup>
						With 1½" Bearing <sup>3,7</sup>		With 3½" Bearing		With 3½" Bearing <sup>3</sup>		With 5¼" Bearing			
						No <sup>4</sup>	Yes <sup>5</sup>	No <sup>4</sup>	Yes <sup>5</sup>	No <sup>4</sup>	Yes <sup>5</sup>	No <sup>4</sup>	Yes <sup>5</sup>		
AJS-25	9½	5,370	1,160	322	5.3	950	1,240	1,175	1,480	2,600	2,850	2,600	2,850	1,875	3.1
	11⅞	6,960	1,490	545	6.7	955	1,335	1,215	1,595	2,690	3,190	2,690	3,190	1,680	3.4
	14	8,380	1,790	798	7.9	960	1,420	1,250	1,700	2,770	3,500	2,770	3,500	1,500	3.7
	16	9,720	2,065	1,082	9.1	970	1,500	1,285	1,800	2,850	3,800	2,850	3,800	1,340	3.9
	18	10,975	3,010	1,427	12.3	N/A	2,240 <sup>7</sup>	N/A	2,620	N/A	4,720	N/A	4,720	3,200 <sup>8</sup>	4.6
	20	12,270	3,240	1,813	13.7		2,490 <sup>7</sup>		2,980		5,110		5,110		4.9
	22	13,455	3,470	2,249	15.0		2,490 <sup>7</sup>		3,150		5,230		5,505	2,700 <sup>8</sup>	5.1
	24	14,625	3,690	2,737	16.5		2,490 <sup>7</sup>		3,320		5,345		5,900		5.4
AJS-25v	9¼	5,200	1,130	302	5.3	1,075	1,075	1,120	1,120	2,600	2,850	3,100	3,350	2,000	3.1
	9½	5,370	1,160	322	5.4	1,075	1,075	1,145	1,145	2,600	2,850	3,100	3,350	2,000	3.1
	11¼	6,540	1,400	480	6.4	1,250	1,250	1,370	1,370	2,760	3,200	3,250	3,700	2,000	3.4
	11⅞	6,960	1,490	545	6.8	1,250	1,250	1,440	1,440	2,760	3,200	3,250	3,700	2,000	3.4
	14	8,380	1,790	798	8.0	1,250	1,250	1,490	1,680	3,020	3,500	3,500	4,000	2,000	3.7
	16	9,720	2,065	1,082	9.1	1,250	1,250	1,490	1,900	3,020	3,800	3,500	4,000	2,000	3.9
AJS-30	18	13,905	3,010	1,575	12.3	N/A	2,240 <sup>7</sup>	N/A	2,620	N/A	4,720	N/A	4,720	3,200 <sup>8</sup>	4.6
	20	15,540	3,240	1,998	13.7		2,490 <sup>7</sup>		2,980		5,110		5,110		4.9
	22	17,040	3,470	2,477	15.0		2,490 <sup>7</sup>		3,150		5,230		5,505	2,700 <sup>8</sup>	5.1
	24	18,525	3,690	3,012	16.5		2,490 <sup>7</sup>		3,320		5,345		5,900		5.4

For SI: 1 inch = 25.4 mm; 1 ft-lb = 1.36 N-m; 1 in<sup>2</sup>-lb = 179 mm<sup>2</sup>-N, 1 in-lb/in = 4.4 N-mm/mm; 1 lb = 4.45 N; 1 lb/ft = 14.6 N/m.

<sup>1</sup>For I-joist description, see Table 1.

<sup>2</sup>Deflections are calculated using standard engineering formulae for bending deflection and 8M/K for shear deflection. Refer to Section 4.10 in this report.

<sup>3</sup>Minimum bearing length required.

<sup>4</sup>No = Web stiffener is not required.

<sup>5</sup>Yes = Web stiffener required. See Figure 1.

<sup>6</sup>Allowable vertical-load capacity for I-joists used as blocking panels.

<sup>7</sup>For I-joists with depths greater than or equal to 18 inches, the minimum end bearing length must be 1¾ inches.

<sup>8</sup>Web stiffeners required at each end of blocking panel. See Figure 1. Distance between stiffeners must be ≤ 24 inches.

<sup>9</sup>The tabulated reference design reaction values, R<sub>r</sub>, are for normal duration of load and are permitted to be adjusted for other load durations in accordance with the NDS, provided the adjusted design reaction, R<sub>r</sub><sup>'</sup>, does not exceed the adjusted flange bearing capacity, P<sub>c⊥</sub>, calculated as follows:

$$P_{c\perp} = F_{c\perp}' P_b (w_f - 0.15)$$

where: F<sub>c⊥</sub>' = 425 psi for end reactions, 470 psi for 3½-inch intermediate reactions, and 455 psi for 5¼-inch intermediate reactions.

P<sub>b</sub> = Bearing length in inches.

w<sub>f</sub> = The nominal width of the flange in inches.

<sup>10</sup>AJS joists with attached fire protection, add 0.3 lb/ft to the listed weight for Thermax™, add 0.8 lb/ft to the listed weight for FireBreak Hits® and 0.6 lb/ft to the listed weight for HHO™ fire-protective overlay.

<sup>11</sup>Maximum lateral load transfer capacity for all AJS joists is 720 plf (see Table 4).

TABLE 3—AJS ALLOWABLE FLOOR SPANS<sup>1,2,3,4,5,6,7</sup>

SERIES	DEPTH (inches)	ON-CENTER SPACING			
		12 inches	16 inches	19.2 inches	24 inches
AJS-5	9 1/2	18' - 6"	16' - 0"	14' - 7"	13' - 0"
	11 7/8	21' - 1"	18' - 3"	16' - 7"	14' - 10"
AJS-10	9 1/2	21' - 2"	18' - 8"	17' - 0"	15' - 3"
	11 7/8	24' - 7"	21' - 3"	19' - 5"	17' - 4"
	14	27' - 0"	23' - 5"	21' - 4"	18' - 11"
AJS-20	16	29' - 1"	25' - 2"	23' - 0"	*20' - 4"
	9 1/2	21' - 2"	19' - 4"	18' - 3"	16' - 4"
	11 7/8	25' - 2"	22' - 10"	20' - 10"	18' - 7"
	14	28' - 6"	25' - 0"	22' - 10"	*20' - 3"
AJS-20v	16	31' - 2"	27' - 0"	*24' - 5"	*21' - 10"
	9 1/4	20' - 8"	18' - 10"	17' - 10"	16' - 8"
	9 1/2	21' - 1"	19' - 3"	18' - 2"	17' - 0"
	11 1/4	24' - 0"	22' - 0"	20' - 9"	19' - 1"
	11 7/8	25' - 1"	22' - 11"	21' - 8"	19' - 8"
AJS-110	14	28' - 5"	26' - 0"	24' - 2"	*21' - 7"
	16	31' - 6"	28' - 7"	*26' - 1"	*23' - 3"
	9 1/4	16' - 10"	14' - 7"	13' - 3"	11' - 10"
	9 1/2	17' - 1"	14' - 9"	13' - 6"	12' - 1"
	11 1/4	18' - 11"	16' - 4"	14' - 11"	13' - 4"
	11 7/8	19' - 6"	16' - 10"	15' - 4"	13' - 9"
AJS-140	14	21' - 5"	18' - 6"	16' - 11"	15' - 1"
	16	22' - 10"	19' - 9"	18' - 0"	16' - 1"
	9 1/2	19' - 9"	17' - 0"	15' - 6"	13' - 10"
	11 7/8	22' - 4"	19' - 4"	17' - 8"	15' - 9"
	14	24' - 7"	21' - 3"	19' - 5"	17' - 4"
AJS-150	16	26' - 6"	22' - 11"	20' - 11"	18' - 8"
	9 1/2	20' - 1"	18' - 3"	16' - 7"	14' - 10"
	11 7/8	23' - 11"	20' - 9"	18' - 11"	16' - 11"
	14	26' - 4"	22' - 9"	20' - 9"	18' - 7"
AJS-150v	16	28' - 5"	24' - 7"	22' - 5"	*19' - 10"
	9 1/4	19' - 7"	17' - 11"	16' - 5"	14' - 8"
	9 1/2	20' - 0"	18' - 3"	16' - 8"	14' - 10"
	11 1/4	22' - 10"	20' - 2"	18' - 4"	16' - 5"
	11 7/8	23' - 10"	20' - 9"	19' - 0"	16' - 11"
AJS-160	14	26' - 4"	22' - 10"	20' - 10"	18' - 7"
	16	28' - 5"	24' - 7"	22' - 5"	*20' - 0"
	9 1/2	20' - 5"	18' - 9"	17' - 4"	15' - 6"
	11 7/8	24' - 4"	21' - 8"	19' - 9"	17' - 8"
AJS-170	14	27' - 5"	23' - 9"	21' - 8"	*19' - 2"
	16	29' - 7"	25' - 7"	23' - 4"	*20' - 8"
	9 1/2	20' - 9"	19' - 0"	18' - 0"	16' - 1"
	11 7/8	24' - 9"	22' - 6"	20' - 6"	18' - 4"
AJS-180	14	28' - 1"	24' - 8"	22' - 6"	*19' - 11"
	16	30' - 9"	26' - 7"	24' - 1"	*21' - 6"
	9 1/2	21' - 2"	19' - 4"	18' - 3"	16' - 11"
	11 7/8	25' - 2"	23' - 0"	21' - 4"	*19' - 1"
AJS-190	14	28' - 6"	25' - 8"	23' - 8"	*21' - 0"
	16	31' - 7"	27' - 11"	*25' - 4"	*22' - 7"
	9 1/4	21' - 0"	19' - 3"	18' - 2"	16' - 11"
	9 1/2	21' - 5"	19' - 7"	18' - 6"	17' - 3"
	11 1/4	24' - 6"	22' - 4"	21' - 2"	*19' - 2"
	11 7/8	25' - 6"	23' - 4"	22' - 0"	*19' - 9"
	14	28' - 11"	26' - 5"	*24' - 4"	*21' - 8"
AJS-200	16	32' - 0"	28' - 11"	*26' - 2"	*23' - 5"
	18	35' - 3"	30' - 11"	28' - 2"	25' - 2"
	20	37' - 9"	32' - 8"	29' - 10"	26' - 8"
	9 1/2	21' - 9"	19' - 11"	18' - 10"	17' - 6"
	11 7/8	25' - 11"	23' - 8"	22' - 4"	*20' - 5"
AJS-24	14	9' - 4"	26' - 10"	*25' - 4"	*22' - 5"
	16	32' - 6"	*29' - 8"	*27' - 1"	*24' - 2"
	9 1/4	21' - 7"	19' - 8"	18' - 7"	17' - 4"
	9 1/2	22' - 0"	20' - 1"	19' - 0"	17' - 9"
	11 1/4	25' - 1"	22' - 11"	21' - 8"	19' - 0"
AJS-24	11 7/8	26' - 2"	23' - 11"	22' - 7"	19' - 0"
	14	29' - 8"	27' - 1"	23' - 10"	19' - 1"
	16	32' - 11"	28' - 11"	24' - 1"	19' - 3"



TABLE 3—AJS ALLOWABLE FLOOR SPANS<sup>1,2,3,4,5,6,7</sup> (Continued)

SERIES	DEPTH (inches)	ON-CENTER SPACING			
		12 inches	16 inches	19.2 inches	24 inches
AJS25	9 1/2	23' - 3"	21' - 3"	20' - 1"	18' - 8"
	11 7/8	27' - 8"	25' - 3"	23' - 10"	*22' - 2"
	14	31' - 5"	28' - 8"	*27' - 0"	*24' - 8"
	16	34' - 9"	*31' - 8"	*29' - 11"	*25' - 4"
	18	38' - 2"	34' - 10"	32' - 11"	29' - 6"
	20	41' - 4"	37' - 8"	34' - 10"	31' - 2"
	22	44' - 4"	40' - 0"	36' - 6"	32' - 8"
AJS25v	24	47' - 4"	41' - 9"	38' - 1"	34' - 0"
	9 1/4	22' - 8"	20' - 9"	19' - 7"	18' - 3"
	9 1/2	23' - 2"	21' - 2"	20' - 0"	18' - 7"
	11 1/4	26' - 5"	24' - 2"	22' - 9"	21' - 3"
	11 7/8	27' - 7"	25' - 2"	23' - 9"	*22' - 2"
	14	31' - 4"	28' - 7"	*26' - 11"	*24' - 10"
AJS30	16	34' - 7"	*31' - 7"	*29' - 10"	*24' - 10"
	18	39' - 4"	35' - 10"	33' - 10"	31' - 6"
	20	42' - 6"	38' - 10"	36' - 7"	34' - 1"
	22	45' - 8"	41' - 8"	39' - 4"	36' - 8"
	24	48' - 9"	44' - 8"	42' - 0"	38' - 4"

For SI: 1 inch = 25.4 mm; 1 psf = 47.88 Pa.

<sup>1</sup>For assemblies consisting of minimum 23/32-inch-thick Sturd-I-Floor rated sheathing nailed to the I-joists in accordance with the applicable code and adhered to the top flanges of the I-joists using ASTM D3498 or AFG-01 construction adhesive.

<sup>2</sup>Spans are based on a uniform residential floor loading of 40 psf live load and 10 psf dead load.

<sup>3</sup>Spans are for simply supported joists.

<sup>4</sup>Minimum end bearing length is 1 1/2 inches for joist depths 16 inches or less, and 1 3/4 inches for joist depths 18 inches or greater, except for spans\* (marked with an asterisk) which must have a minimum 3 1/2-inch bearing length.

<sup>5</sup>Maximum spans are measured in accordance with Section 4.9, and are based on uniformly loaded joists.

<sup>6</sup>Live load deflection is limited to L/360; total load deflection is limited to L/240.

<sup>7</sup>Allowable spans take into consideration the composite effect from the glued and nailed subfloor for deflection purposes.

TABLE 4—ALLOWABLE SHEAR (PLF) FOR HORIZONTAL WOOD STRUCTURAL PANEL DIAPHRAGMS FRAMED WITH AJS JOISTS FOR WIND<sup>1</sup> OR SEISMIC LOADING<sup>2,3,9</sup>

Sheathing Grade	Common Nail Size	Minimum Nominal Panel Thickness (in.)	Minimum Nominal Width of Framing Members at Adjoining Edges and Boundaries (in.) <sup>4</sup>	Blocked Diaphragms			Unblocked Diaphragms	
				Nail Spacing (in.) at Diaphragm Boundaries (All Cases), at Continuous Panel Edges Parallel to Load (Cases 3 & 4), and at All Panel Edges (Cases 5 & 6) <sup>5,6</sup>			Nails Spaced 6 in. Max at Supported Edges <sup>5</sup>	
				6	4	2-1/2 <sup>7</sup>	Case 1 (No Unblocked Edges or Continuous Joints Parallel to Load)	All Other Configurations (Cases 2, 3, 4, 5 & 6)
				Nail Spacing (in.) at Other Panel Edges (Cases 1, 2, 3 & 4) <sup>5</sup>				
Structural I	6d <sup>8</sup>	5/16	3	210	280	420	185	140
	8d	3/8	3	300	400	600	265	200
	10d	15/32	3	360	480	720	320	240
Sheathing and Single Floor	6d <sup>8</sup>	5/16	3	190	250	380	170	125
		3/8	3	210	280	420	185	140
	8d	3/8	3	270	360	540	240	180
		7/16	3	285	380	570	255	190
		15/32	3	300	400	600	265	200
	10d	15/32	3	325	430	650	290	215
		19/32	3	360	480	720	320	240

For SI: 1 inch = 25.4 mm; 1 plf = 14.6 N/m.

<sup>1</sup>For wind load applications, the values in the table above shall be permitted to be multiplied by 1.4.

<sup>2</sup>For shear loads of normal or permanent load duration as defined in the NDS, the values in the table above shall be multiplied by 0.63 or 0.56, respectively.

<sup>3</sup>The tabulated allowable shear capacities are for I-joist series with flanges having a specific gravity (G) of 0.50 or higher (see Table 1). For G < 0.50 the allowable shear capacities shall be reduced by multiplying the allowable shear capacities by the Specific Gravity Adjustment Factor = [1-(0.5-G)]. The Specific Gravity Adjustment Factor shall not be greater than 1.

<sup>4</sup>Minimum flange widths of AJS framing members are 2-1/2 inches (3 inches nominal).

<sup>5</sup>Space nails maximum 12 inches o.c. along intermediate framing members (6 inches o.c. when supports are spaced 48 inches o.c. or greater). Fasteners shall be located 3/8 inch minimum from panel edges.

<sup>6</sup>When nail spacing is 4 inches on center at diaphragm boundaries, adjacent nails within a row must be offset (staggered) 1/2 inch.

<sup>7</sup>When nail spacing is 2-1/2 inches on center at adjoining panel edges, adjacent nails within a row must be offset (staggered) 1/2 inch.

<sup>8</sup>8d common nails minimum are recommended for roof panel attachments.

<sup>9</sup>See Table 4.2A of SDPWS for diaphragm configurations.

**TABLE 5—MINIMUM DISTANCE FROM INSIDE FACE OF SUPPORT TO NEAREST EDGE OF ROUND HOLE FOR JOIST DEPTHS OF 9 1/2 TO 16 INCHES<sup>1,2,3,4,5,6</sup>**

SPAN (ft)	MINIMUM DISTANCE (ft-in)										
	Based on Joist Depth (in)										
	9 1/2		11 7/8		14			16			
	And Based on Hole Diameter (in)										
	3	6	3	6	3	6	9	3	6	9	12
8	1' - 0"	2' - 0"	1' - 0"	1' - 0"	1' - 0"	1' - 0"	1' - 0"	1' - 0"	1' - 0"	1' - 0"	1' - 0"
10	1' - 0"	3' - 0"	1' - 0"	1' - 0"	1' - 0"	1' - 0"	1' - 0"	1' - 0"	1' - 0"	1' - 0"	1' - 0"
12	1' - 0"	4' - 0"	1' - 0"	1' - 0"	1' - 0"	1' - 0"	1' - 0"	1' - 0"	1' - 0"	1' - 0"	2' - 0"
14	1' - 6"	5' - 6"	1' - 0"	1' - 6"	1' - 0"	1' - 0"	2' - 0"	1' - 0"	1' - 0"	1' - 0"	3' - 0"
16	2' - 6"	6' - 6"	1' - 0"	3' - 0"	1' - 0"	1' - 0"	3' - 6"	1' - 0"	1' - 0"	1' - 0"	4' - 0"
18	3' - 6"	8' - 0"	1' - 0"	4' - 0"	1' - 0"	1' - 0"	4' - 6"	1' - 0"	1' - 0"	1' - 6"	5' - 0"
20	4' - 6"	9' - 0"	1' - 6"	5' - 6"	1' - 0"	2' - 0"	5' - 6"	1' - 0"	1' - 0"	3' - 0"	6' - 6"
22	6' - 0"	10' - 6"	2' - 6"	6' - 0"	1' - 0"	3' - 0"	7' - 0"	1' - 0"	1' - 0"	4' - 0"	7' - 6"
24	7' - 0"	11' - 6"	3' - 6"	7' - 6"	1' - 0"	4' - 6"	8' - 0"	1' - 0"	1' - 6"	5' - 0"	9' - 0"
26	—	—	5' - 0"	8' - 6"	2' - 0"	5' - 6"	9' - 0"	1' - 0"	3' - 0"	6' - 0"	10' - 0"
28	—	—	6' - 0"	10' - 0"	3' - 0"	6' - 6"	10' - 6"	1' - 0"	4' - 0"	7' - 6"	11' - 6"
30	—	—	—	—	4' - 0"	7' - 6"	11' - 6"	1' - 6"	5' - 0"	8' - 6"	12' - 6"
32	—	—	—	—	5' - 6"	9' - 0"	13' - 0"	3' - 0"	6' - 0"	9' - 6"	14' - 0"
34	—	—	—	—	—	—	—	4' - 0"	7' - 0"	11' - 0"	15' - 0"

For SI: 1 inch = 25.4 mm; 1 psf = 47.88 Pa.

<sup>1</sup>Table is based on simple span, uniform loading of 40 psf (live) and 15 psf (dead), joist spacing less than or equal to 24 inches, and reference design shear values.

<sup>2</sup>For multiple span or concentrated loads, shear at the hole location must not exceed what a uniform load would produce in a simple span at the distance shown in the table.

<sup>3</sup>Where more than one hole is desired, the length of web between holes must be equal to twice the diameter of the largest hole.

<sup>4</sup>Flanges may not be cut or notched.

<sup>5</sup>A 1 1/2-inch-diameter hole may be cut anywhere in the web.

<sup>6</sup>See Figure 2 in this report for details.

**TABLE 6—MINIMUM DISTANCE FROM INSIDE FACE OF SUPPORT TO NEAREST EDGE OF ROUND HOLE FOR JOIST DEPTHS OF 18 TO 24 INCHES<sup>1,2,3,4,5,6</sup>**

SPAN (ft)	MINIMUM DISTANCE (ft-in)											
	Based on Joist Depth (in)											
	18			20			22			24		
	And Based on Hole Diameter (in)											
	4.5	9	13.5	5	10	15	5.5	11	16.5	6	12	18
10	1' - 0"	1' - 0"	1' - 0"	1' - 0"	1' - 0"	1' - 0"	1' - 0"	1' - 0"	1' - 0"	1' - 0"	1' - 0"	1' - 0"
12	1' - 0"	1' - 0"	2' - 0"	1' - 0"	1' - 0"	1' - 6"	1' - 0"	1' - 0"	1' - 0"	1' - 0"	1' - 0"	1' - 0"
14	1' - 0"	1' - 0"	3' - 6"	1' - 0"	1' - 0"	2' - 6"	1' - 0"	1' - 0"	1' - 6"	1' - 0"	1' - 0"	1' - 0"
16	1' - 0"	1' - 0"	4' - 6"	1' - 0"	1' - 0"	3' - 6"	1' - 0"	1' - 0"	2' - 6"	1' - 0"	1' - 0"	2' - 0"
18	1' - 0"	1' - 0"	5' - 6"	1' - 0"	1' - 0"	4' - 6"	1' - 0"	1' - 0"	4' - 0"	1' - 0"	1' - 0"	3' - 0"
20	1' - 0"	1' - 0"	7' - 0"	1' - 0"	1' - 0"	6' - 0"	1' - 0"	1' - 0"	5' - 0"	1' - 0"	1' - 0"	4' - 0"
22	1' - 0"	1' - 0"	8' - 0"	1' - 0"	1' - 0"	7' - 0"	1' - 0"	1' - 0"	6' - 0"	1' - 0"	1' - 0"	5' - 6"
24	1' - 0"	1' - 0"	9' - 6"	1' - 0"	1' - 0"	8' - 6"	1' - 0"	1' - 0"	7' - 6"	1' - 0"	1' - 0"	6' - 6"
26	1' - 0"	2' - 0"	10' - 6"	1' - 0"	1' - 0"	9' - 6"	1' - 0"	1' - 0"	8' - 6"	1' - 0"	1' - 0"	7' - 6"
28	1' - 0"	3' - 6"	12' - 0"	1' - 0"	2' - 0"	10' - 6"	1' - 0"	1' - 0"	9' - 6"	1' - 0"	1' - 0"	9' - 0"
30	1' - 0"	4' - 6"	13' - 0"	1' - 0"	3' - 0"	12' - 0"	1' - 0"	2' - 0"	11' - 0"	1' - 0"	1' - 0"	10' - 0"
32	1' - 0"	5' - 6"	14' - 6"	1' - 0"	4' - 0"	13' - 0"	1' - 0"	3' - 0"	12' - 0"	1' - 0"	2' - 0"	11' - 6"
34	1' - 0"	6' - 6"	15' - 6"	1' - 0"	5' - 6"	14' - 6"	1' - 0"	4' - 0"	13' - 6"	1' - 0"	3' - 0"	12' - 6"
36	1' - 0"	7' - 6"	17' - 0"	1' - 0"	6' - 6"	15' - 6"	1' - 0"	5' - 0"	14' - 6"	1' - 0"	4' - 0"	13' - 6"
38	1' - 6"	9' - 0"	18' - 0"	1' - 0"	7' - 6"	17' - 0"	1' - 0"	6' - 0"	16' - 0"	1' - 0"	5' - 0"	15' - 0"
40	—	—	—	1' - 0"	8' - 6"	18' - 0"	1' - 0"	7' - 6"	17' - 0"	1' - 0"	6' - 0"	16' - 0"

For SI: 1 inch = 25.4 mm; 1 psf = 47.88 Pa.

<sup>1</sup>Table is based on simple span, uniform loading of 40 psf (live) and 15 psf (dead), joist spacing less than or equal to 24 inches and reference design shear values.

<sup>2</sup>For multiple span or concentrated loads, shear at the hole location must not exceed what a uniform load would produce in a simple span at the distance shown in the table.

<sup>3</sup>Where more than one hole is desired, the length of web between holes must be equal to twice the diameter of the largest hole.

<sup>4</sup>Flanges may not be cut or notched.

<sup>5</sup>A 1 1/2-inch-diameter hole may be cut anywhere in the web.

<sup>6</sup>See Figure 2 in this report for details.



**TABLE 7—MINIMUM DISTANCE FROM INSIDE FACE OF SUPPORT TO NEAREST EDGE OF RECTANGULAR HOLE FOR JOIST DEPTHS OF 9 1/2 TO 16 INCHES** <sup>1,2,3,4,5,6</sup>

SPAN (ft)	MINIMUM DISTANCE (ft-in)												
	Based on Joist Depth (in)												
	9 1/2			11 7/8				14			16		
	And Based on Hole Dimensions (in)												
	5 x 8	5 x 10	5 x 12	5 x 14	7 x 10	7 x 12	7 x 14	7 x 16	10 x 12	10 x 14	10 x 16	12 x 14	12 x 16
8	1' - 6"	2' - 0"	2' - 6"	3' - 0"	1' - 6"	2' - 0"	2' - 6"	3' - 0"	2' - 0"	2' - 6"	3' - 0"	2' - 6"	3' - 0"
10	3' - 0"	3' - 0"	3' - 6"	4' - 0"	2' - 6"	3' - 0"	3' - 6"	4' - 0"	3' - 0"	3' - 6"	4' - 6"	3' - 6"	4' - 6"
12	4' - 0"	4' - 6"	5' - 0"	5' - 6"	3' - 6"	4' - 0"	5' - 0"	5' - 6"	4' - 6"	5' - 0"	5' - 6"	4' - 6"	5' - 6"
14	5' - 0"	5' - 6"	6' - 0"	6' - 6"	5' - 0"	5' - 6"	6' - 0"	6' - 6"	5' - 6"	6' - 0"	—	6' - 0"	—
16	6' - 6"	7' - 0"	7' - 6"	—	6' - 0"	6' - 6"	7' - 6"	—	6' - 6"	7' - 6"	—	7' - 0"	—
18	7' - 6"	8' - 0"	8' - 6"	—	7' - 6"	8' - 0"	8' - 6"	—	8' - 0"	—	—	8' - 6"	—
20	9' - 0"	9' - 6"	—	—	8' - 6"	9' - 0"	—	—	9' - 0"	—	—	9' - 6"	—
22	10' - 0"	10' - 6"	—	—	10' - 0"	10' - 6"	—	—	10' - 6"	—	—	—	—
24	11' - 6"	—	—	—	11' - 0"	11' - 6"	—	—	—	—	—	—	—
26	—	—	—	—	12' - 6"	—	—	—	—	—	—	—	—
28	—	—	—	—	13' - 6"	—	—	—	—	—	—	—	—
30	—	—	—	—	—	—	—	—	—	—	—	—	—
32	—	—	—	—	—	—	—	—	—	—	—	—	—
34	—	—	—	—	—	—	—	—	—	—	—	—	—

For **SI**: 1 inch = 25.4 mm; 1 psf = 47.88 Pa.

<sup>1</sup>Table is based on simple span, uniform loading of 40 psf (live) and 15 psf (dead), joist spacing less than or equal to 24 inches and reference design shear values.

<sup>2</sup>For multiple span or concentrated loads, shear at the hole location must not exceed what a uniform load would produce in a simple span at the distance shown in the table.

<sup>3</sup>Where more than one hole is desired, the length of web between holes must be equal to twice the greatest dimension of the largest hole.

<sup>4</sup>Flanges may not be cut or notched.

<sup>5</sup>A 1 1/2-inch-diameter hole may be cut anywhere in the web.

<sup>6</sup>See Figure 2 in this report for details.

**TABLE 8—MINIMUM DISTANCE FROM INSIDE FACE OF SUPPORT TO NEAREST EDGE OF SQUARE HOLE FOR JOIST DEPTHS OF 18 TO 24 INCHES** <sup>1,2,3,4,5,6</sup>

SPAN (ft)	MINIMUM DISTANCE (ft-in)											
	Based on Joist Depth (in)											
	18			20			22			24		
	And Based on Hole Dimensions (in)											
	10 x 10	12 x 12	14 x 14	12 x 12	14 x 14	16 x 16	12 x 12	14 x 14	16 x 16	14 x 14	16 x 16	18 x 18
8	1' - 0"	1' - 0"	2' - 0"	1' - 0"	1' - 0"	3' - 0"	1' - 0"	1' - 0"	2' - 0"	1' - 0"	1' - 0"	3' - 6"
10	1' - 0"	1' - 0"	3' - 6"	1' - 0"	2' - 0"	4' - 6"	1' - 0"	1' - 0"	3' - 0"	1' - 0"	2' - 0"	4' - 6"
12	1' - 0"	2' - 0"	4' - 6"	1' - 0"	3' - 0"	5' - 6"	1' - 0"	2' - 0"	4' - 6"	1' - 0"	3' - 0"	4' - 6"
14	1' - 0"	3' - 6"	6' - 0"	2' - 0"	4' - 6"	—	1' - 0"	3' - 0"	5' - 6"	2' - 0"	4' - 6"	—
16	2' - 6"	4' - 6"	7' - 0"	3' - 0"	5' - 6"	—	2' - 0"	4' - 6"	7' - 0"	3' - 0"	5' - 6"	—
18	3' - 6"	5' - 6"	8' - 6"	4' - 6"	7' - 0"	—	3' - 0"	5' - 6"	8' - 0"	4' - 6"	7' - 0"	—
20	4' - 6"	7' - 0"	9' - 6"	5' - 6"	8' - 0"	—	4' - 0"	6' - 6"	9' - 6"	5' - 6"	8' - 0"	—
22	5' - 6"	8' - 0"	—	6' - 6"	9' - 0"	—	5' - 6"	8' - 0"	10' - 6"	6' - 6"	9' - 6"	—
24	7' - 0"	9' - 6"	—	8' - 6"	10' - 6"	—	6' - 6"	9' - 0"	—	8' - 0"	10' - 6"	—
26	8' - 0"	10' - 6"	—	9' - 0"	12' - 0"	—	7' - 6"	10' - 6"	—	9' - 0"	12' - 0"	—
28	9' - 0"	12' - 0"	—	10' - 6"	13' - 0"	—	9' - 0"	11' - 6"	—	10' - 6"	13' - 0"	—
30	10' - 6"	13' - 0"	—	11' - 6"	14' - 6"	—	10' - 0"	13' - 0"	—	11' - 6"	14' - 6"	—
32	11' - 6"	14' - 6"	—	13' - 0"	15' - 6"	—	11' - 6"	14' - 0"	—	12' - 6"	15' - 6"	—
34	13' - 0"	15' - 6"	—	14' - 0"	—	—	12' - 6"	15' - 6"	—	14' - 0"	—	—

For **SI**: 1 inch = 25.4 mm; 1 psf = 47.88 Pa.

<sup>1</sup>Table is based on simple span, uniform loading of 40 psf (live) and 15 psf (dead), joist spacing less than or equal to 24 inches and reference design shear values.

<sup>2</sup>For multiple span or concentrated loads, shear at the hole location must not exceed what a uniform load would produce in a simple span at the distance shown in the table.

<sup>3</sup>Where more than one hole is desired, the length of web between holes must be equal to twice the greatest dimension of the largest hole.

<sup>4</sup>Flanges may not be cut or notched.

<sup>5</sup>A 1 1/2-inch-diameter hole may be cut anywhere in the web.

<sup>6</sup>See Figure 2 in this report for details.

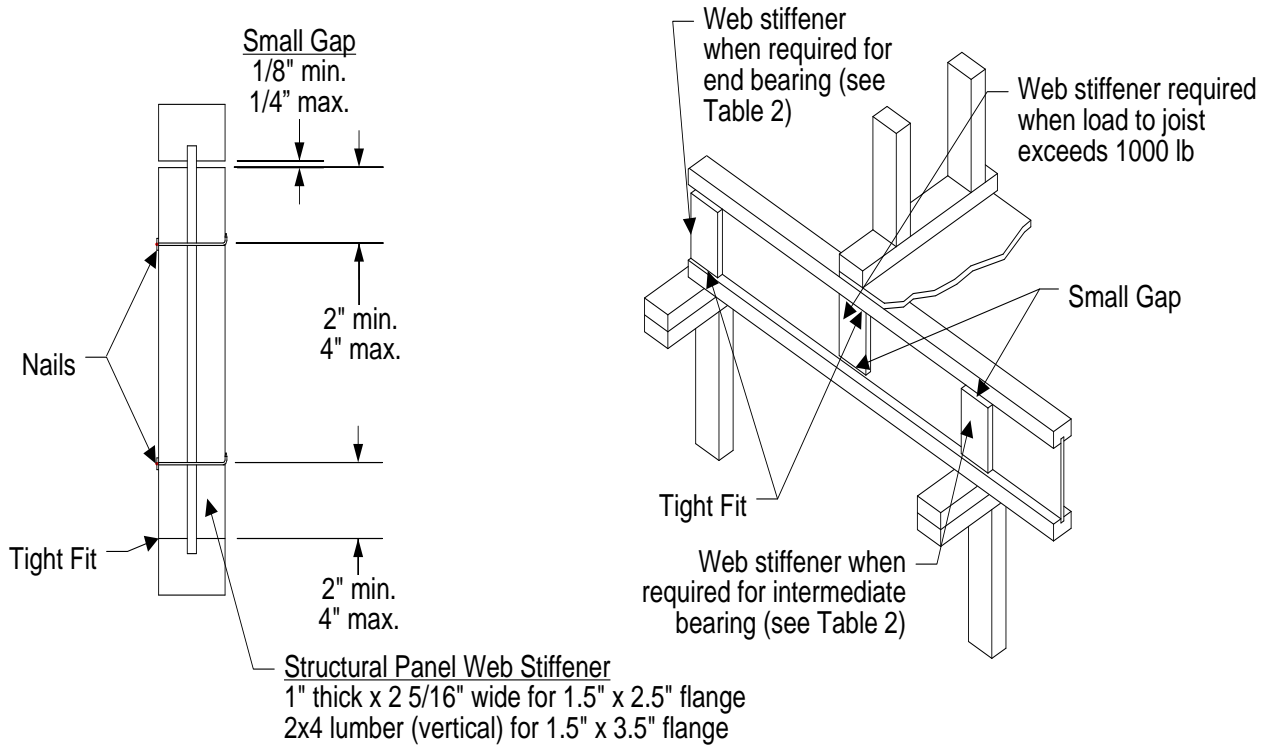

Web Stiffener Fastener Schedule	
Joist Depth	Minimum Required Fasteners
9 1/4" - 11 7/8"	3-10d (3" x 0.125")
14" - 24"	5-10d (3" x 0.125")

FIGURE 1—WEB-STIFFENER INSTALLATION REQUIREMENTS

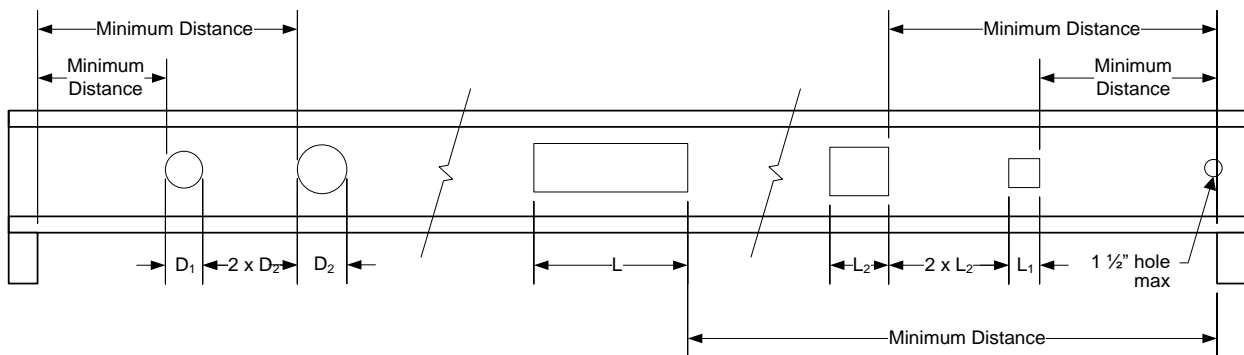
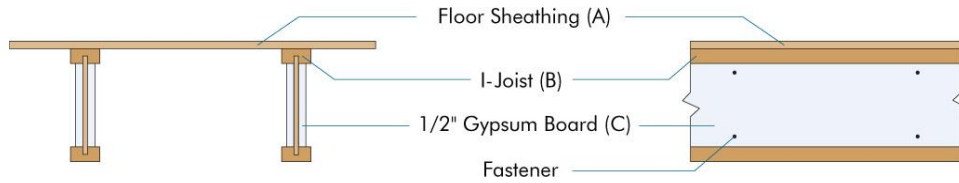

FIGURE 2—HOLE-IN-WEB REQUIREMENTS

**1/2-inch-thick Gypsum Board Attached to Web**



(A) **Floor Sheathing:** Materials and installation must be per Section R503 of the 2018, 2015 or 2012 IRC

(B) **I-Joist:** Installation per Section 4.0 of this evaluation report. Minimum flange size of 1.5 inches x 2.0 inches. Minimum web thickness of 3/8 inch.

(C) **1/2-inch-thick Gypsum Board:** Materials (entire length of I-joist) per Section R702.3.1 of the 2018, 2015 or 2012 IRC (not required to be finished with tape and joint compound). **Fasteners:** Min. 1-inch-long screws (Type W or Type S) or nails installed

1 inch from edges and 16 inches on center, top and bottom. Fasteners may be staggered from top to bottom.

**Installation Requirements at Web Holes**

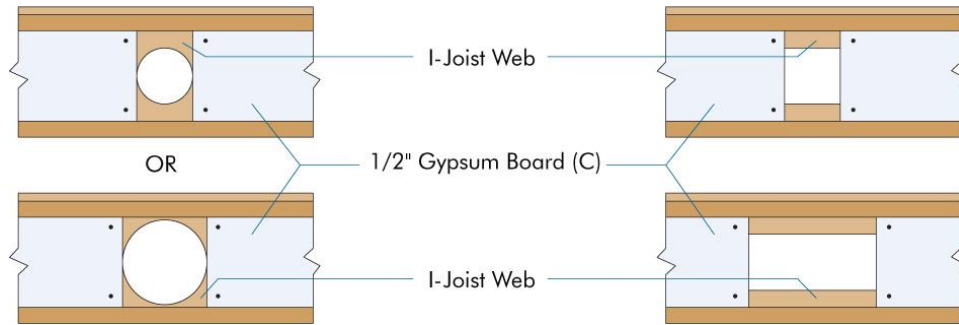

**Note:** At hole location, fasteners must be installed 1 inch from the edge of the gypsum board and horizontally spaced a distance equivalent to the hole width/diameter plus 2 inches.

**Crawl Space Exception**

Per Exception 2 of 2018 and 2015 IRC Section R302.13 or 2012 IRC Section R501.3, floor assemblies located directly over a crawl space not intended for storage or fuel-fired appliances do not require additional fire protection.



**Automatic Sprinkler System Exception**

Per Exception 1 of 2018 and 2015 IRC Section R302.13 or 2012 IRC Section R501.3, floor assemblies located directly over a space protected by an automatic sprinkler system do not require additional fire protection.

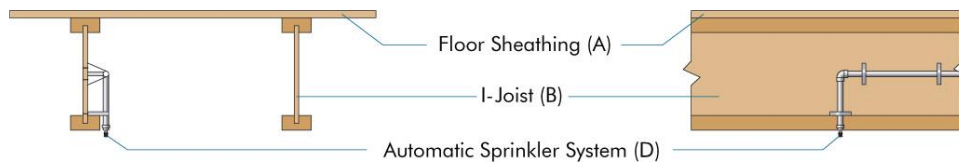

(D) **Automatic Sprinkler System:** System in accordance with Section P2904 of the 2018, 2015 or 2012 IRC, NFPA 13D, or other equivalent sprinkler system. **Note:** Per 2018, 2015 or 2012 IRC Section P2904, partial residential sprinkler systems are permitted to be installed only in buildings not required to be equipped with a residential sprinkler system. Check with the local building official for specific jurisdictional requirements.

For **SI:** 1 inch = 25.4 mm

**FIGURE 3—FIRE PROTECTION: 2018 OR 2015 IRC SECTION R302.13 OR 2012 IRC SECTION R501.3, EXCEPTIONS 1 AND 2, AND EXCEPTION 4; 1/2-INCH-THICK GYPSUM BOARD ATTACHED DIRECTLY TO WEB**

**1/2-inch-thick Gypsum Board Attached to Sides of Flange**

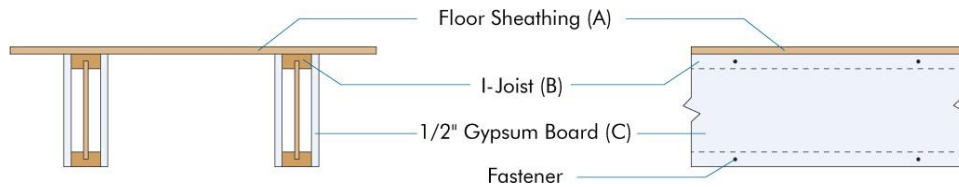

(A) **Floor Sheathing:** Materials and installation must be per Section R503 of the 2018, 2015 or 2012 IRC

(B) **I-Joist:** Installation per Section 4.0 of this evaluation report. Minimum flange size of 1.125 inches x 1.75 inches. Minimum web thickness of 3/8 inch.

(C) **1/2-inch-thick Gypsum Board:** Materials (entire length of I-joist) per Section R702.3.1 of the 2018, 2015 or 2012 IRC (not required to be finished with tape and joint compound). **Fasteners:** Min. 1-inch-long screws (Type W or Type S) or nails installed

1/2 inch from edges and 16 inches on center, top and bottom. Fasteners may be staggered from top to bottom.

**Installation Requirements at Web Holes**

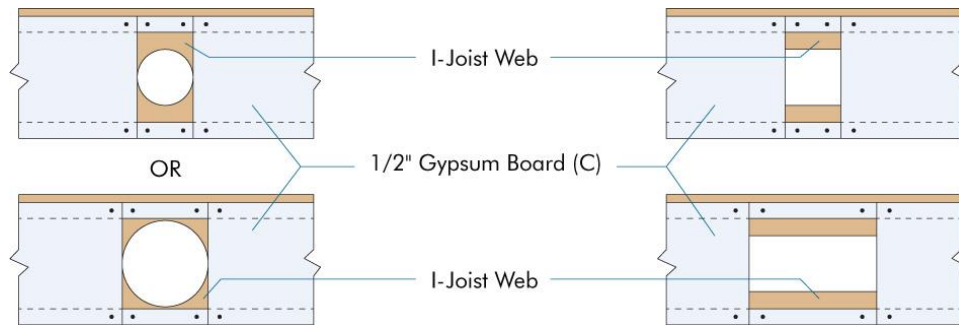

**Note:** At hole location, fasteners shall be installed 1 inch from the edge of the gypsum board and horizontally spaced a distance equivalent to the hole width/diameter plus 2 inches. Maximum spacing shall be no more than 8 inches on gypsum board above and below the hole.

**Crawl Space Exception**

Per Exception 2 of 2018 and 2015 IRC Section R302.13 or 2012 IRC Section R501.3, floor assemblies located directly over a crawl space not intended for storage or fuel-fired appliances do not require additional fire protection.



**Automatic Sprinkler System Exception**

Per Exception 1 of 2018 and 2015 IRC Section R302.13 or 2012 IRC Section R501.3, floor assemblies located directly over a space protected by an automatic sprinkler system do not require additional fire protection.

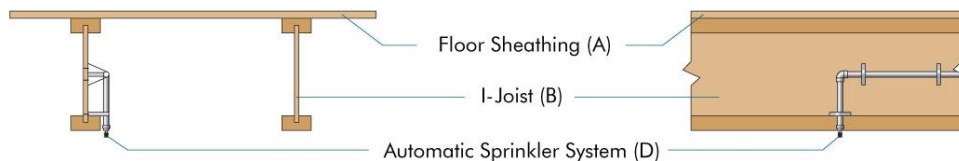

(D) **Automatic Sprinkler System:** System in accordance with Section P2904 of the 2018, 2015 or 2012 IRC, NFPA 13D, or other equivalent sprinkler system. **Note:** Per 2018, 2015 or 2012 IRC Section P2904, partial residential sprinkler systems are permitted to be installed only in buildings not required to be equipped with a residential sprinkler system. Check with the local building official for specific jurisdictional requirements.

For **SI:** 1 inch = 25.4 mm

**FIGURE 4—FIRE PROTECTION: 2018 OR 2015 IRC SECTION R302.13 OR 2012 IRC SECTION R501.3, EXCEPTIONS 1 AND 2, AND, EXCEPTION 4; 1/2-INCH-THICK GYPSUM BOARD ATTACHED DIRECTLY TO SIDES OF FLANGE**

**Mineral Wool Insulation**

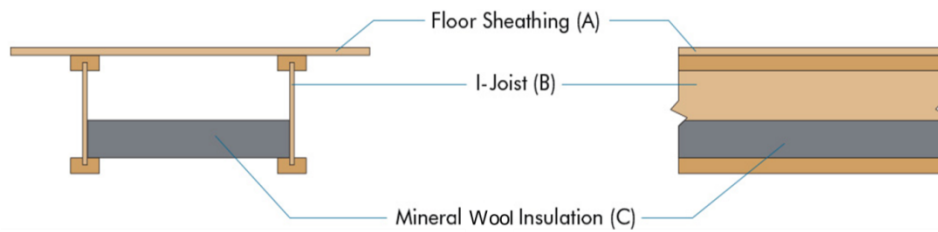

**(A) Floor Sheathing:** Materials and installation must be per Section R503 of the 2018, 2015 or 2012 IRC

**(B) I-Joist:** Installation per Section 4.0 of this evaluation report. Minimum flange size of 1.125 inches x 2.0 inches. Minimum web thickness of 3/8 inch. Maximum center-to-center spacing of 24 inches.

**(C) Mineral Wool Batt Insulation:** 3-inch-thick, minimum 2.5 lb per ft<sup>3</sup> mineral wool batt insulation made of rock or furnace slag (ASTM C665 Type 1 compliant) installed as shown with insulation stay wire supports spaced no more than 24 inches apart and no more than 6 inches from ends of batts. The insulation width must be a minimum of 15 1/4 inches wide when installed between joists that are 16 inches on center or 23 inches wide when installed between joists that are 24 inches on center. The insulation batts must be properly located on top of the I-joist bottom flange and installed without gaps between individual batts.

**Crawl Space Exception**

Per Exception 2 of 2018 and 2015 IRC Section R302.13 or 2012 IRC Section R501.3, floor assemblies located directly over a crawl space not intended for storage or fuel-fired appliances do not require additional fire protection. Note: insulation may be required for energy code compliance purposes; check with the local building official for specific jurisdictional requirements.



**Automatic Sprinkler System Exception**

Per Exception 1 of 2018 and 2015 IRC Section R302.13 or 2012 IRC Section R501.3, floor assemblies located directly over a space protected by an automatic sprinkler system do not require additional fire protection. Note: insulation may be required for energy code compliance purposes; check with the local building official for specific jurisdictional requirements.

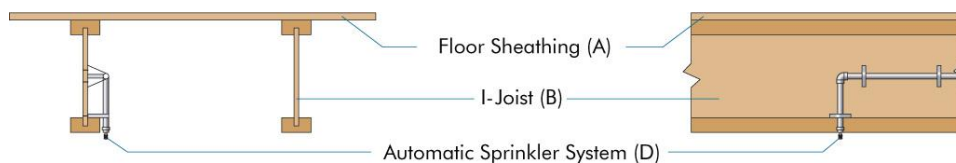

**(D) Automatic Sprinkler System:** System in accordance with Section P2904 of the 2018, 2015 or 2012 IRC, NFPA 13D, or other equivalent sprinkler system. **Note:** Per 2018, 2015 or 2012 IRC Section P2904, partial residential sprinkler systems are permitted to be installed only in buildings not required to be equipped with a residential sprinkler system. Check with the local building official for specific jurisdictional requirements.

For **SI:** 1 inch = 25.4 mm, 1 lb/ft<sup>3</sup> = 16 kg/m<sup>3</sup>

**FIGURE 5—FIRE PROTECTION: 2018 OR 2015 IRC SECTION R302.13 OR 2012 IRC SECTION R501.3, EXCEPTIONS 1 AND 2, AND EXCEPTION 4; MINERAL WOOL BATT INSULATION**

**Ceramic Fiber Blanket Attached on Web**

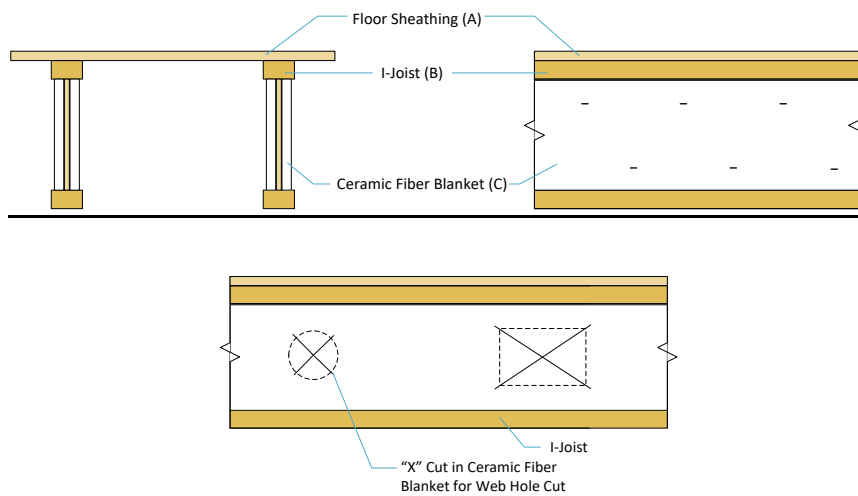

- (A) **Floor Sheathing:** Materials and installation must be per Section R503 of the 2018, 2015 or 2012 IRC.
- (B) **I-Joist:** Installation per Section 4.0 of this ESR report. Minimum flange size of 1 1/2-inch-thick-by-2 5/16-inch-wide. Minimum web thickness of 3/8 inch.
- (C) **Ceramic Fiber Blanket:** 3/4-inch-thick, minimum 4 lb per ft<sup>3</sup>, Mei Guo International, LLC (USA) FireBreak<sup>®</sup> proprietary ceramic fiber blanket made of aluminum oxide and silicon dioxide (ASTM C892 Type III compliant) is attached directly on web as shown with two rows of 7/8-inch-long crown staples installed staggered at 8 inches horizontal on-center spacing. The maximum vertical staple-to-staple distance between two rows of staples must be 3 inches with additional rows of staples added as necessary for i-joist depth greater than 9 1/2 inches. The ceramic blanket must fill the web space with no gaps, and contact both inside flange faces to protect the web. Joist spacing up to 24 inches on center is allowed. Holes should be 1 inch larger than service dimension, and an "X" cut in the ceramic fiber blanket on both sides to allow wire/pipe/duct to pass through.

**Crawl Space Exception**

Per Exception 2 of 2018 and 2015 IRC Section R302.13 or 2012 IRC Section R501.3, floor assemblies located directly over a crawl space not intended for storage or fuel-fired appliances do not require additional fire protection. Note: insulation may be required for energy code compliance purposes; check with the local building official for specific jurisdictional requirements.



**Automatic Sprinkler System Exception**

Per Exception 1 of 2018 and 2015 IRC Section R302.13 or 2012 IRC Section R501.3, floor assemblies located directly over a space protected by an automatic sprinkler system do not require additional fire protection. Note: insulation may be required for energy code compliance purposes; check with the local building official for specific jurisdictional requirements.

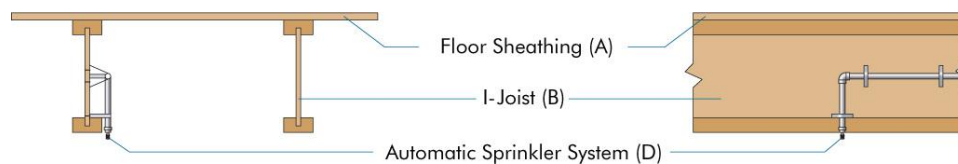

- (D) **Automatic Sprinkler System:** System in accordance with Section P2904 of the 2018, 2015 or 2012 IRC, NFPA 13D, or other equivalent sprinkler system. **Note:** Per 2018, 2015 or 2012 IRC Section P2904, partial residential sprinkler systems are permitted to be installed only when the entire dwelling unit is not required to be equipped with a residential sprinkler system. Check with the local building official for specific jurisdictional requirements.

For **SI:** 1 inch = 25.4 mm, 1 lb/ft<sup>3</sup> = 16 kg/m<sup>3</sup>

**FIGURE 6—FIRE PROTECTION: 2018 OR 2015 IRC SECTION R302.13 OR 2012 IRC SECTION R501.3, EXCEPTIONS 1 AND 2, AND EXCEPTION 4; CERAMIC FIBER BLANKET ATTACHED DIRECTLY ON WEB**



**Drop-in Gypsum Board**

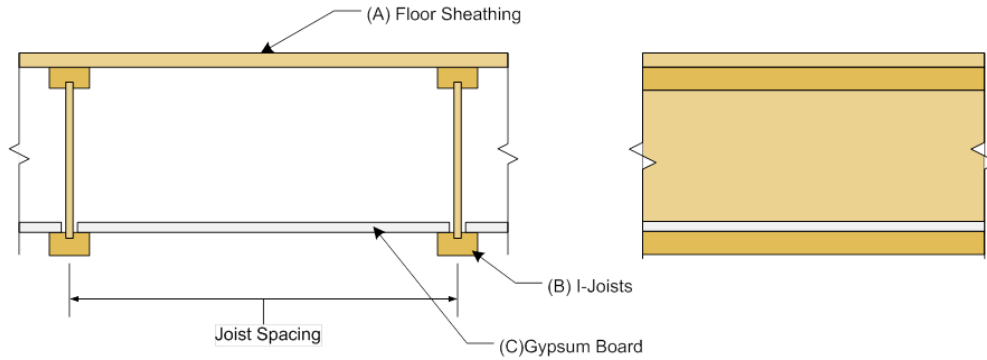

- (A) Floor Sheathing: Materials and installation must be per Section R503 of the 2018, 2015 or 2012 IRC.
- (B) I-Joist: Installation per Section 4.0 of this evaluation report. Minimum flange size of 1.125 inches x 2.0 inches. Minimum web thickness of  $\frac{3}{8}$  inch. The maximum I-joist center-to-center spacing is either 19.2 inches or 24 inches.
- (C) Gypsum Wallboard Drop-In Panel: For 19.2 inches maximum I-joist spacing, one layer of minimum  $\frac{1}{2}$ -inch-thick gypsum wallboard must be used. For 24 inches maximum I-joist spacing, 1 layer of minimum  $\frac{5}{8}$ -inch-thick gypsum wallboard must be used. Gypsum wallboards must comply to ASTM C1396 for gypsum wallboards. The drop-in panel is installed on the top surface of the bottom flange. Mechanical fastener or adhesive attachment to the top surface of the bottom flange is not required. A maximum gap of  $\frac{5}{16}$  inch between the edge of the gypsum and the I-joist web shall be permitted. Penetrations or openings for ducts, vents, electrical outlets, lighting, devices, luminaires, wires, speakers, drainage, piping and similar openings or penetrations on I-joist web shall be permitted.

**Crawl Space Exception**

Per Exception 2 of 2018 and 2015 IRC Section R302.13 or 2012 IRC Section R501.3, floor assemblies located directly over a crawl space not intended for storage or fuel-fired appliances do not require additional fire protection. Note: insulation may be required for energy code compliance purposes; check with the local building official for specific jurisdictional requirements.



**Automatic Sprinkler System Exception**

Per Exception 1 of 2018 and 2015 IRC R302.13 or 2012 IRC Section R501.3.13, floor assemblies located directly over a space protected by an automatic sprinkler system do not require additional fire protection. Note: insulation may be required for energy code compliance purposes; check with the local building official for specific jurisdictional requirements.

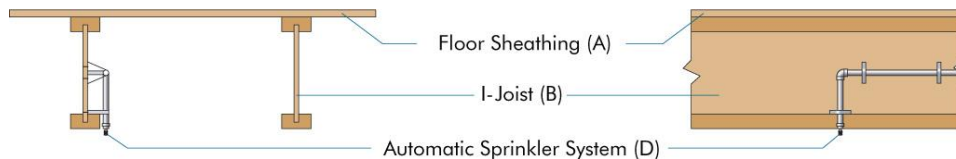

- (D) Automatic Sprinkler System: System in accordance with Section P2904 of the 2018, 2015 or 2012 IRC, NFPA 13D, or other equivalent sprinkler system. **Note:** Per 2018, 2015 or 2012 IRC Section P2904, partial residential sprinkler systems are permitted to be installed only in buildings not required to be equipped with a residential sprinkler system. Check with the local building official for specific jurisdictional requirements.

For SI: 1 inch = 25.4 mm

**FIGURE 7—FIRE PROTECTION: 2018 OR 2015 IRC SECTION R302.13 OR 2012 IRC SECTION R501.3, EXCEPTIONS 1 AND 2, AND EXCEPTION 4; DROP-IN GYPSUM BOARD**

**FireBreak HITS™**

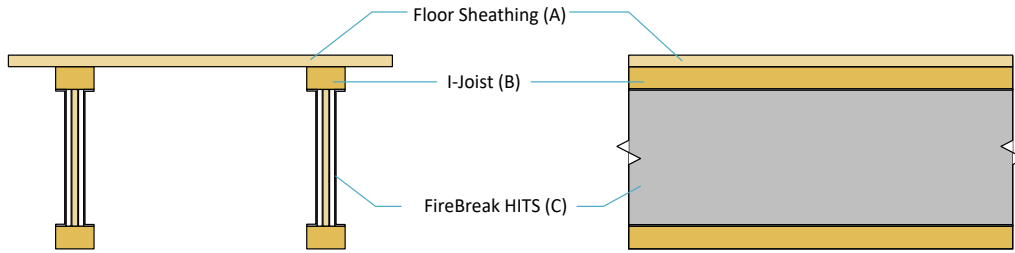

- (A) Floor Sheathing: Materials and installation must be per Section R503 of the 2018, 2015 or 2012 IRC.
- (B) I-Joist: Installation per Section 4.0 of this evaluation report. Minimum flange size of 1.5 inches x 2.31 inches. Minimum web thickness of 3/8 inch. 24 inch on center maximum spacing.
- (C) FiberBreak HITS™ fire protection material consists of one layer of ceramic fiber board covered with one layer of intumescent paper adhered to the ceramic fiber board. The FireBreak HITS™ is glued to the I-joist web with the intumescent paper permitted not to be adhered to the top surface of the bottom flanges and the bottom surface of the top flanges of I-joists.

**Crawl Space Exception**

Per Exception 2 of 2018 and 2015 IRC Section R302.13 or 2012 IRC Section R501.3, floor assemblies located directly over a crawl space not intended for storage or fuel-fired appliances do not require additional fire protection. Note: insulation may be required for energy code compliance purposes; check with the local building official for specific jurisdictional requirements.



**Automatic Sprinkler System Exception**

Per Exception 1 of 2018 and 2015 IRC Section R302.13 or 2012 IRC Section R501.3, floor assemblies located directly over a space protected by an automatic sprinkler system do not require additional fire protection. Note: insulation may be required for energy code compliance purposes; check with the local building official for specific jurisdictional requirements.

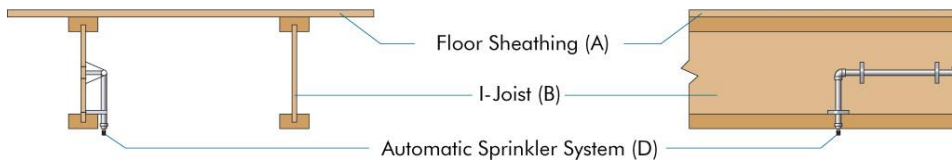

- (D) Automatic Sprinkler System: System in accordance with Section P2904 of the 2018, 2015 or 2012 IRC, NFPA 13D, or other equivalent sprinkler system. **Note:** Per 2018, 2015 or 2012 IRC Section P2904, partial residential sprinkler systems are permitted to be installed only in buildings not required to be equipped with a residential sprinkler system. Check with the local building official for specific jurisdictional requirements.

For **SI**: 1 inch = 25.4 mm, 1 lb/ft<sup>3</sup> = 16 kg/m<sup>3</sup>

**FIGURE 8—FIRE PROTECTION: 2018 OR 2015 IRC SECTION R302.13 OR 2012 IRC SECTION R501.3, EXCEPTIONS 1 AND 2, AND EXCEPTION 4; FIREBREAK HITS™**

**Factory-Applied Thermax™ Sheathing Board**

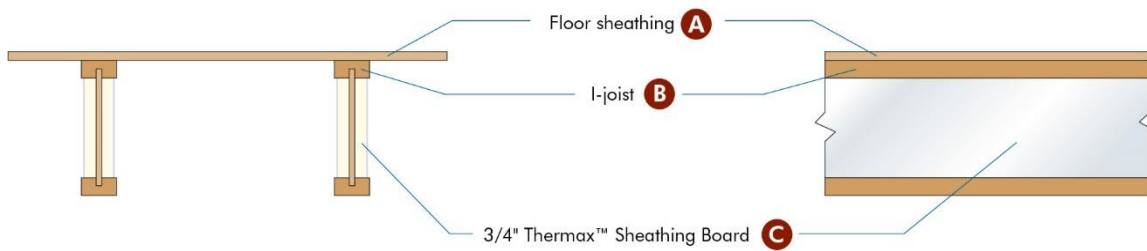

- (A) Floor sheathing: Materials and installation must be per Section R503 of the 2018, 2015 or 2012 IRC.
- (B) I-joist: Installation per Section 4.0 of this evaluation report. Maximum 24 inches on center spacing. Minimum flange size of 1½ inches thick x 2½ inches wide. Minimum web thickness of 3⁄8 inch.
- (C) Factory-applied proprietary Thermax™ Sheathing Board: One layer of 3⁄4-inch thick Thermax™ Sheathing board conforming to ICC-ES [ESR-1659](#) is adhered to each side of the I-joist web in accordance with the in-plant manufacturing standard.

**Crawl Space Exception**

Per Exception 2 of 2018 and 2015 IRC Section R302.13 or 2012 IRC Section R501.3, floor assemblies located directly over a crawl space not intended for storage or fuel-fired appliances do not require additional fire protection. Note: insulation may be required for energy code compliance purposes; check with the local building official for specific jurisdictional requirements.



**Automatic Sprinkler System Exception**

Per Exception 1 of 2018 and 2015 IRC Section R302.13 or 2012 IRC Section R501.3, floor assemblies located directly over a space protected by an automatic sprinkler system do not require additional fire protection. Note: insulation may be required for energy code compliance purposes; check with the local building official for specific jurisdictional requirements.

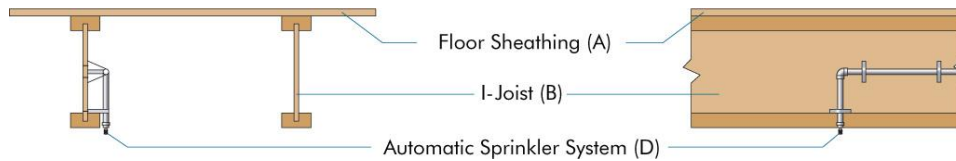

- (D) Automatic sprinkler system: System in accordance with Section P2904 of the 2018, 2015 or 2012 IRC, NFPA 13D, or other equivalent sprinkler systems. **Note:** Per 2018, 2015 or 2012 IRC Section P2904, partial residential sprinkler systems are permitted to be installed only in buildings not required to be equipped with a residential sprinkler system. Check with the local building official for specific jurisdictional requirements.

For **SI**: 1 inch = 25.4 mm, 1 lb/ft³ = 16 kg/m³

**FIGURE 9—FIRE PROTECTION: 2018 OR 2015 IRC SECTION R302.13 OR 2012 IRC SECTION R501.3, EXCEPTIONS 1 AND 2, AND EXCEPTION 4; THERMAX™ SHEATHING BOARD**

**Factory-Applied HHO™ Overlay**

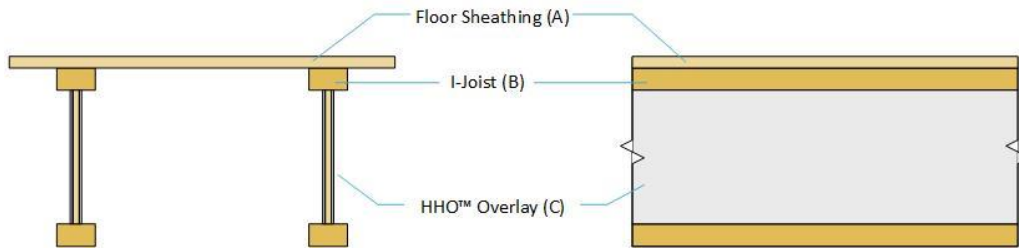

- (A) **Floor Sheathing:** Materials and installation must be per Section R503 of the 2018, 2015 or 2012 IRC.
- (B) **I-Joist:** Installation per Section 4.0 of this evaluation report. Minimum flange size of 1.5 inches x 2.5 inches. Minimum web thickness of 3/8 inch. 24 inch on center maximum spacing.
- (C) **HHO™ fire protection overlay material** consists of one layer of overlay mechanically fastened to the I-joist web with staples in accordance with the in-plant manufacturing standard.

**Crawl Space Exception**

Per Exception 2 of 2018 and 2015 IRC Section R302.13 or 2012 IRC Section R501.3, floor assemblies located directly over a crawl space not intended for storage or fuel-fired appliances do not require additional fire protection. Note: insulation may be required for energy code compliance purposes; check with the local building official for specific jurisdictional requirements.



**Automatic Sprinkler System Exception**

Per Exception 1 of 2018 and 2015 IRC Section R302.13 or 2012 IRC Section R501.3, floor assemblies located directly over a space protected by an automatic sprinkler system do not require additional fire protection. Note: insulation may be required for energy code compliance purposes; check with the local building official for specific jurisdictional requirements.

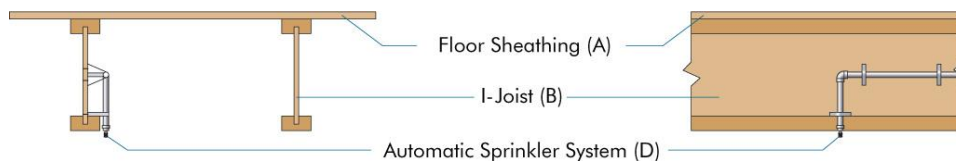

- (D) **Automatic Sprinkler System:** System in accordance with Section P2904 of the 2018, 2015 or 2012 IRC, NFPA 13D, or other equivalent sprinkler system. **Note:** Per 2018, 2015 or 2012 IRC Section P2904, partial residential sprinkler systems are permitted to be installed only in buildings not required to be equipped with a residential sprinkler system. Check with the local building official for specific jurisdictional requirements.

For **SI:** 1 inch = 25.4 mm, 1 lb/ft<sup>3</sup> = 16 kg/m<sup>3</sup>

**FIGURE 10—FIRE PROTECTION: 2018 OR 2015 IRC SECTION R302.13, OR 2012 IRC SECTION R501.3, EXCEPTIONS 1 AND 2, AND EXCEPTION 4; HHO™ Overlay**

**Gypsum Board or Wood Structural Panels Attached to Bottom of Flange**

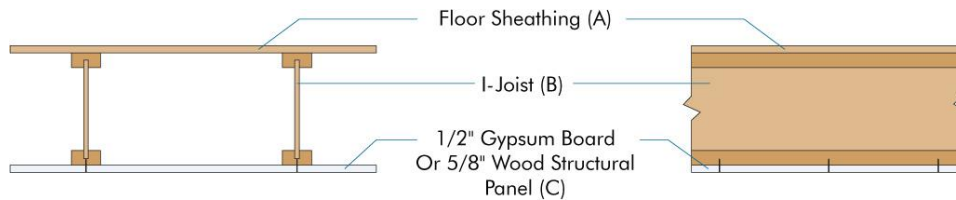

**(A) Floor Sheathing:** Materials and installation must be per Section R503 of the 2018, 2015 or 2012 IRC

**(B) I-Joist:** Installation per Section 4.0 of this evaluation report. Applicable to all flange sizes described in this report. Minimum web thickness of 3/8 inch.

**(C) 1/2-inch-thick Gypsum Board:** Materials and installation per Section R702.3.1 of the 2018, 2015 or 2012 IRC or equivalent. Gypsum Board not required to be finished with tape and joint compound; or **5/8-inch-thick Wood Structural Panel:** Materials and installation per Section R503.2 of the 2018, 2015 or 2012 IRC, or equivalent. Wood Structural Panel not required to be finished with wood filler or sanded.

**Note:** Per Exception 3 of 2018 and 2015 Section R302.13 or 2012 IRC Section R501.3, portions of floor assembly can be unprotected when complying with the following:

- 1) The aggregate area of the unprotected portions shall not exceed 80 square feet per story.
- 2) Fire blocking in accordance with Section R302.11.1 of the 2018, 2015 or 2012 IRC shall be installed along the perimeter of the unprotected portion to separate the unprotected portion from the remainder of the floor assembly.

**Crawl Space Exception**

Per Exception 2 of 2018 and 2015 IRC Section R302.13 or 2012 IRC Section R501.3, floor assemblies located directly over a crawl space not intended for storage or fuel-fired appliances do not require additional fire protection.



**Automatic Sprinkler System Exception**

Per Exception 1 of 2018 and 2015 IRC Section R302.13 or 2012 IRC Section R501.3, floor assemblies located directly over a space protected by an automatic sprinkler system do not require additional fire protection.

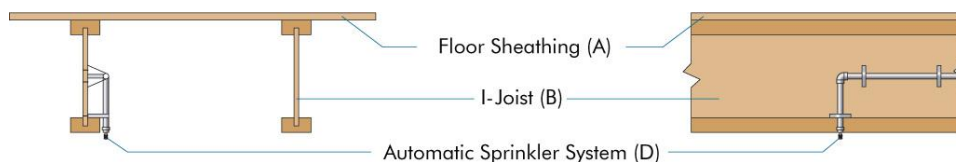

**(D) Automatic Sprinkler System:** System in accordance with Section P2904 of the 2018, 2015 or 2012 IRC, NFPA 13D, or other equivalent sprinkler system. **Note:** Per 2018, 2015 or 2012 IRC Section P2904, partial residential sprinkler systems are permitted to be installed only in buildings not required to be equipped with a residential sprinkler system. Check with the local building official for specific jurisdictional requirements.

For SI: 1 inch = 25.4 mm

**FIGURE 11—2018 OR 2015 IRC SECTION R302.13 OR 2012 IRC SECTION R501.3 FLOOR ASSEMBLY DETAIL**

**DISCLAIMER**

APA Product Report® is a trademark of APA – The Engineered Wood Association, Tacoma, Washington. ICC-ES Evaluation Report is a trademark of ICC Evaluation Service, LLC (ICC-ES). The information contained herein is based on the product evaluation in accordance with the references noted in this report. Neither ICC-ES, nor APA or its members make any warranty, expressed or implied, or assume any legal liability or responsibility for the use, application of, and/or reference to opinions, findings, conclusions, or recommendations included in this report. The joint ICC-ES/APA Evaluation Reports are not to be construed as representing aesthetics or any other attributes not specifically addressed, nor are they to be construed as an endorsement of the subject of the report or a recommendation for its use. Consult the local jurisdiction or design professional to assure compliance with code, construction, and performance requirements. Because neither APA, nor ICC-ES, has any control over quality of workmanship or the conditions under which engineered wood products are used, it cannot accept responsibility for product performance or designs as actually constructed.